

1450

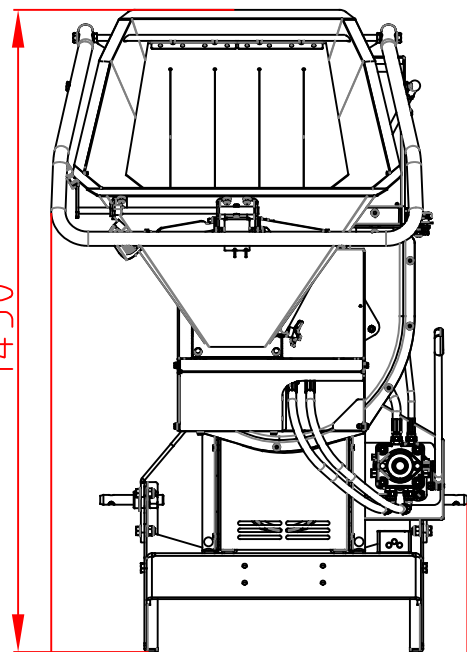

940

1000

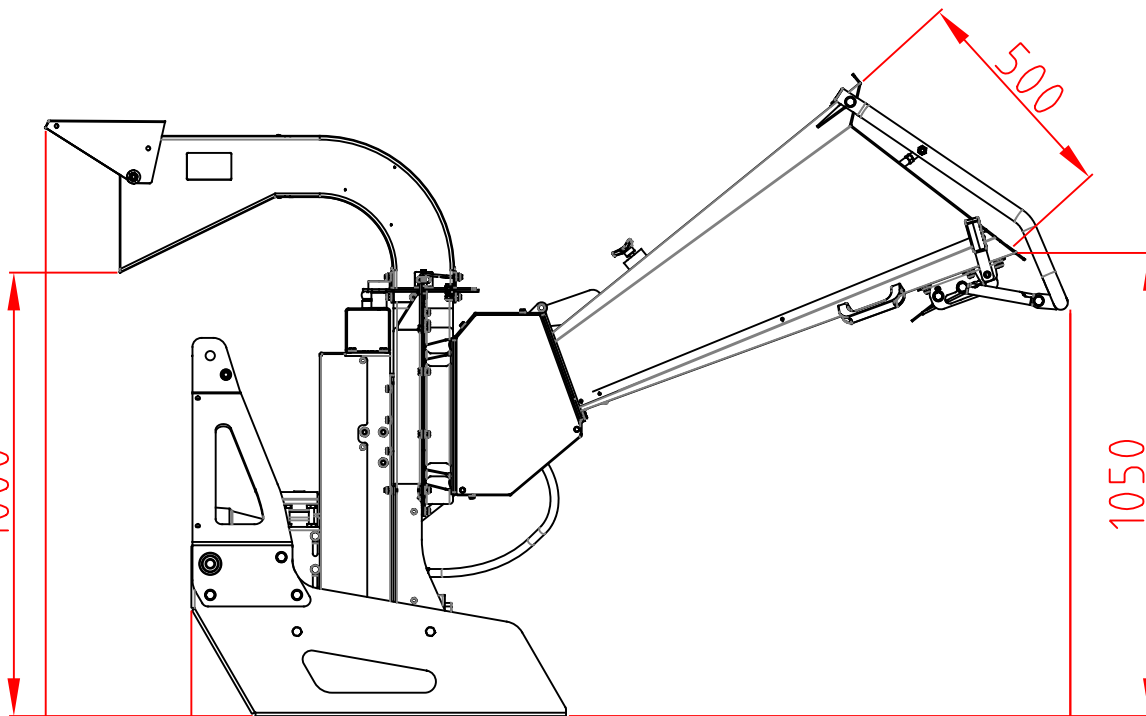

1980

2300

500

1050

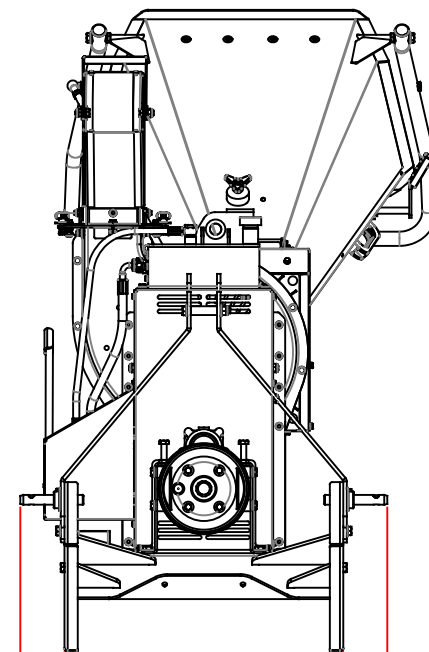

630

825

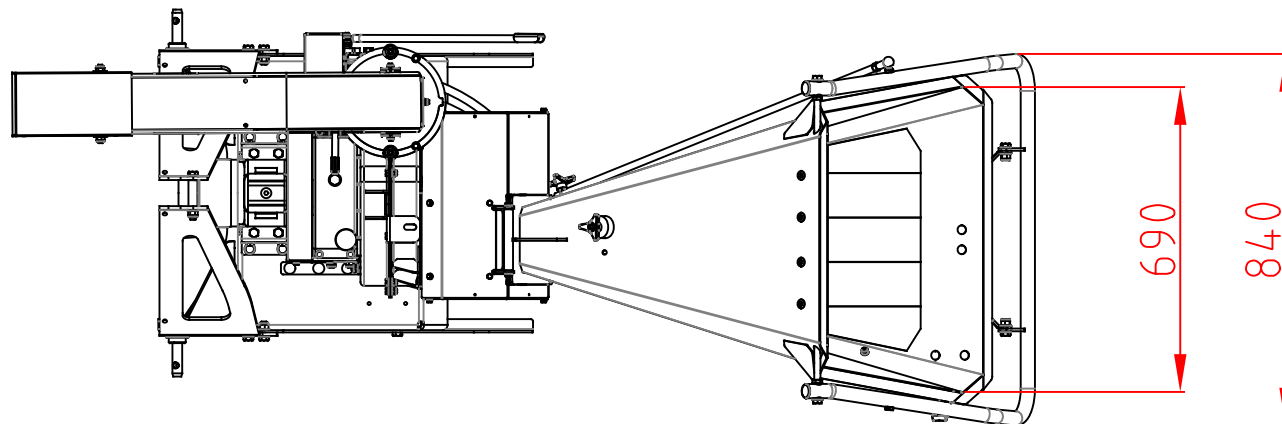

690

840